



Visit us at : <http://www.lgservice.com>

LG

LG

Do(Digital Output) Kit

INSTALLATION MANUAL

Models: PQNFP00T0

ENGLISH

ITALIANO

ESPAÑOL

FRANÇAIS

DEUTSCH

CHINESE

IMPORTANT

- Please read this installation manual completely before installing the product.
- Installation work must be performed in accordance with the national wiring standards by authorized personnel only.
- Please retain this installation manual for future reference after reading it thoroughly.

TABLE OF CONTENTS

| | |
|------------------------------|------|
| ■ Safety Precautions..... | 3~4 |
| ■ Accessory Parts | 5 |
| ■ Components..... | 6 |
| ■ How to set..... | 7~11 |
| ■ Procedure to install | 7 |
| ■ Wiring diagram | 8 |
| ■ How to inspect | 11 |

Safety Precautions



To prevent injury to the user or other people and property damage, the following instructions must be followed.

- Incorrect operation due to ignoring instruction will cause harm or damage. The seriousness is classified by the following indications.

⚠ WARNING This symbol indicates the possibility of death or serious injury.

⚠ CAUTION This symbol indicates the possibility of injury or damage.

- Meanings of symbols used in this manual are as shown below.

| | |
|---|---|
|  | Be sure not to do. |
|  | Be sure to follow the instruction. |

⚠ WARNING

■ Installation

Don't touch with the hands while the power is on

- There is risk of fire or electric shock.

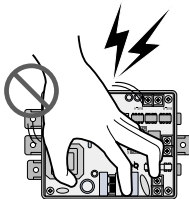

Use standard parts(connector).

- Do not disassemble or repair the product. There is risk of fire or electric shock.

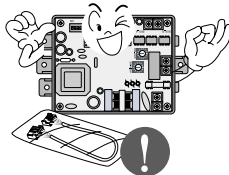

For electrical work, contact the dealer, seller, a qualified electrician, or an Authorized Service Center.

- Do not disassemble or repair the product. There is risk of fire or electric shock.



Use the correctly rated breaker or fuse.

- There is risk of fire or electric shock.

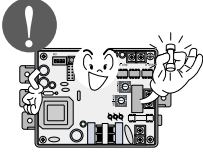

Do not install, remove, or re-install the unit by yourself (customer).

- There is risk of fire, electric shock, explosion, or injury.



For installation, always contact the dealer or an Authorized Service Center.

- There is risk of fire, electric shock, explosion, or injury.



■ Operation

When the product is soaked (flooded or submerged), contact an Authorized Service Center.

- There is risk of fire or electric shock.

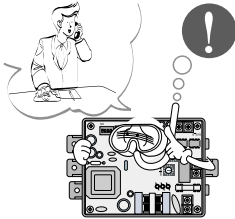

Be cautious that water could not enter the product.

- There is risk of fire, electric shock, or product damage.

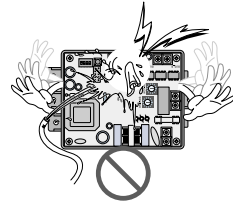

Accessory Parts

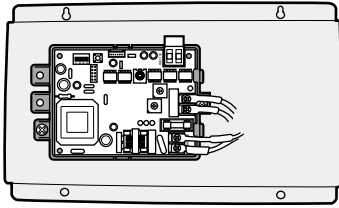

Do Kit : 6871A90053D



Front case

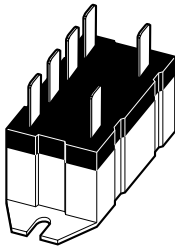

POWER RELAY (G7L-2A-TUB)

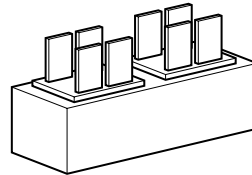

Connection Terminal

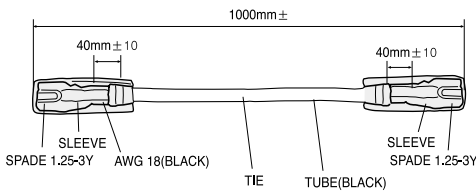

Connection Cable (AWG18*5EA)

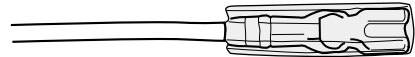

Additional Connection Cable

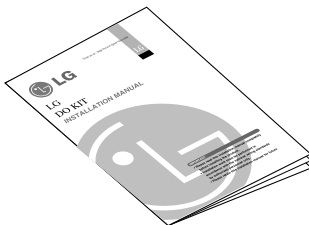

Installation Manual

* Others: Tie wrap for arranging the cable -2EA

Components

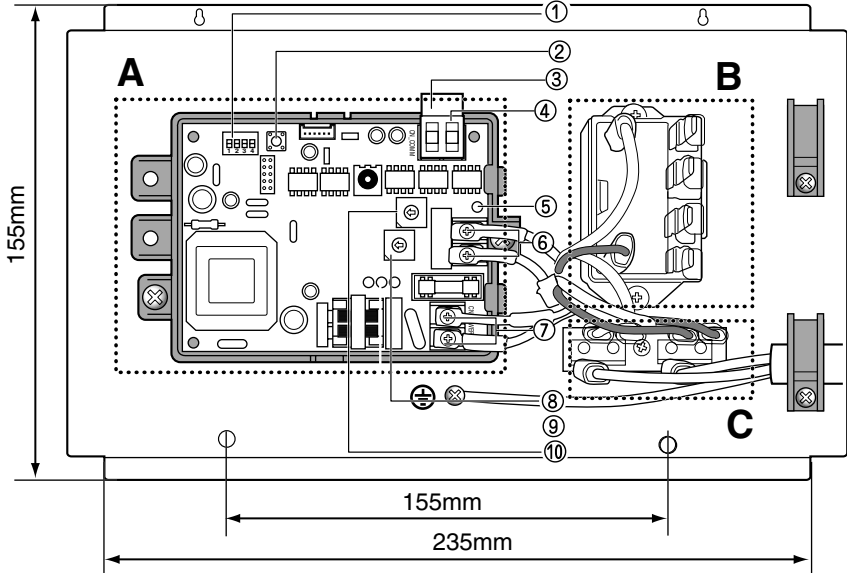

A. DO KIT

- ❶ SW2: Function setting DIP switch
- ❷ SW1: Reset switch
- ❸ BUS_A: 485 communication BUS_A
- ❹ BUS_B: 485 communication BUS_B
- ❺ LD4: 485 communication LED
- ❻ CON_SW: Relay output
- ❼ CN_POWER: 220V power
- ❽ SW_HIGH: Group address setting rotary switch
- ❾ LD2: Relay status LED
- ❿ SW_LOW: Indoor unit address setting rotary switch

B. POWER RELAY

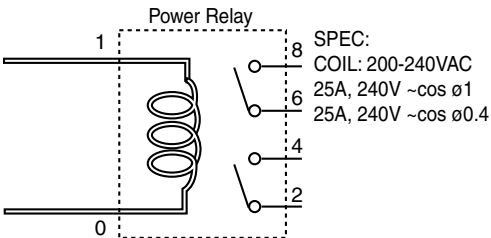

C. CONNECTING TERMINAL

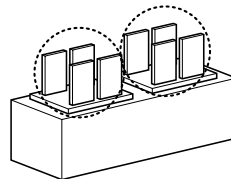

A: AC220V(L)
 B: AC220V(N)

How to set

Procedure to install

1. Use ⑧ and ⑩ rotary switch to set the central control address.

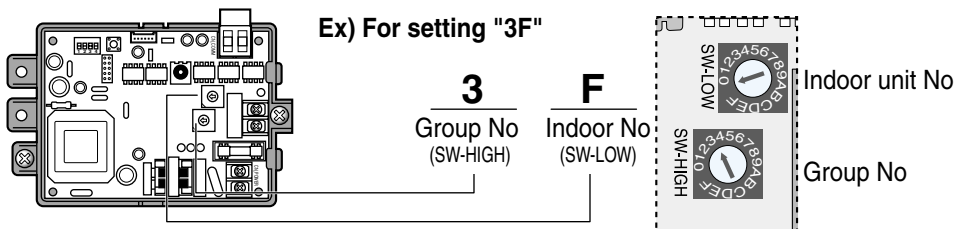

2. Connect the relay output at ⑤ to the power relay.
3. Connect BUS_A at ③ and BUS_B at ④ to the BUS_A and the BUS_B of the CNU or ACP respectively.
4. Set according to the relay ON/OFF function of the DIP switch at ①.

| | |
|----------------------------|---|
| <p>ON ↑</p> <p>1 2 3 4</p> | <ul style="list-style-type: none"> • No. 1 S/W ON : The initial relay is turned on when the power is applied to the contact PI-485 • No. 1 S/W OFF : The initial relay is turned off when the power is applied to the contact PI-485 • No. 2 S/W : Set to OFF • No. 3 S/W ON : The 3-minute delay is disabled when the relay is turned on/off. • No. 3 S/W OFF : The 3-minute delay is enabled when the relay is turned on/off. • No. 4 S/W : Set to ON |
|----------------------------|---|

The above figure shows the initial relay turned off and the 3-minute delay disabled.

5. Apply the 220V power to ⑦.

Wiring diagram

When the product input is less than or equal to 25A

(The air conditioner is controlled by turning on/off the power supply line of the product.)

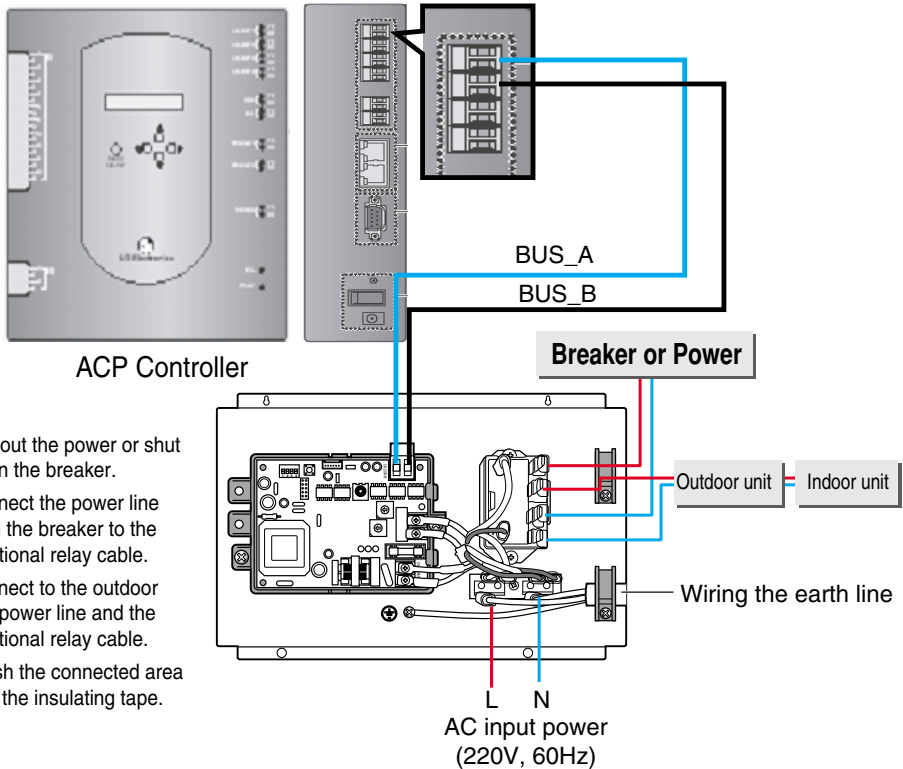

1. Pull out the power or shut down the breaker.
2. Connect the power line from the breaker to the additional relay cable.
3. Connect to the outdoor unit power line and the additional relay cable.
4. Finish the connected area with the insulating tape.

| Central control signal | Do kit | Product |
|------------------------|-------------------------|---|
| Run | Contact ON (Relay ON) | Product power ON (possible to be controlled by the indoor unit) |
| Stop | Contact OFF (Relay OFF) | Product power OFF |

- All central controllers using the LGAP protocol except the ACP can be used.



Note:

- Connecting the communication terminal (BUS_A, BUS_B) and the power terminal (L, N) reversely may damage the product.
- The model with the indoor/outdoor unit communicating the RS485 or other data by the above connection may cause the failure.
- When the power specification connecting to the relay is higher than the specification of the supplied relay, use the separate relay.

When the product input is greater than or equal to 25A

(The air conditioner is controlled by turning on/off the indoor/outdoor communication line.)

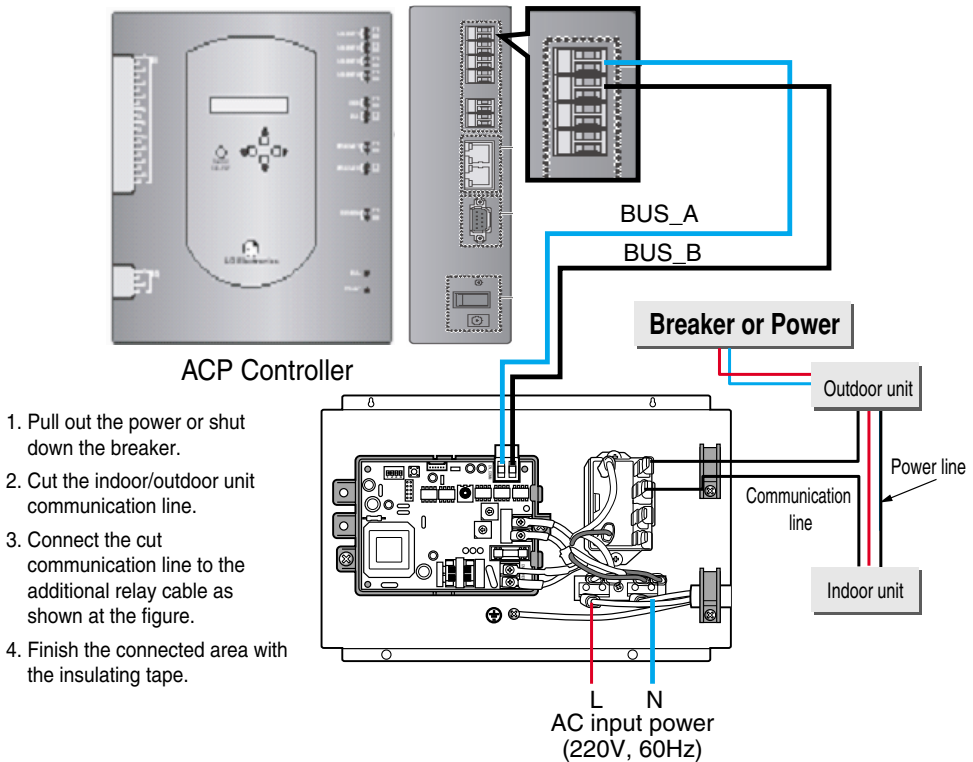

| Central control signal | Do kit | Product |
|------------------------|-------------------------|---|
| Run | Contact ON (Relay ON) | Product power ON (possible to be controlled by the indoor unit) |
| Stop | Contact OFF (Relay OFF) | Product power OFF |

- Even when the stop command is issued by the central control signal when controlling the communication line, only the outdoor unit is stopped, but the indoor unit continues to run according to the product.
- When running is started after being stopped by the central control, the indoor unit returns to the previous running state.
- It is possible to interconnect with all central controllers possible with the LGAP.



Note:

- Connecting the communication terminal (BUS_A, BUS_B) and the power terminal (L, N) reversely may damage the product.
- The model with the indoor/outdoor unit communicating the RS485 or other data by the above connection may cause the failure.
- When the power specification connecting to the relay is higher than the specification of the supplied relay, use the separate relay.

When the product input is greater than or equal to 25A

(The air conditioner is controlled by turning on/off the indoor unit power.)

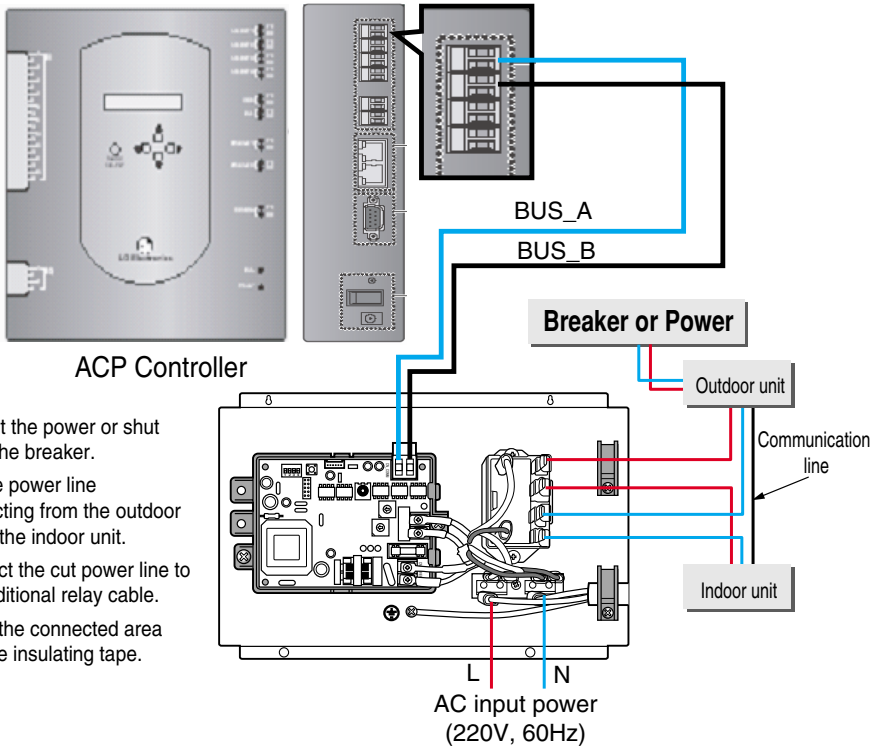

1. Pull out the power or shut down the breaker.
2. Cut the power line connecting from the outdoor unit to the indoor unit.
3. Connect the cut power line to the additional relay cable.
4. Finish the connected area with the insulating tape.

| Central control signal | Do kit | Product |
|------------------------|-------------------------|---|
| Run | Contact ON (Relay ON) | Product power ON (possible to be controlled by the indoor unit) |
| Stop | Contact OFF (Relay OFF) | Impossible to control by turning off the indoor unit power |

- Even when the stop command is issued by the central control signal when controlling the communication line, only the outdoor unit is stopped, but the indoor unit continues to run according to the product.
- When running is started after being stopped by the central control, the indoor unit returns to the previous running state.
- It is possible to interconnect with all central controllers possible with the LGAP.



Note:

- Connecting the communication terminal (BUS_A, BUS_B) and the power terminal (L, N) reversely may damage the product.
- The model with the indoor/outdoor unit communicating the RS485 or other data by the above connection may cause the failure.
- When the power specification connecting to the relay is higher than the specification of the supplied relay, use the separate relay.

How to inspect

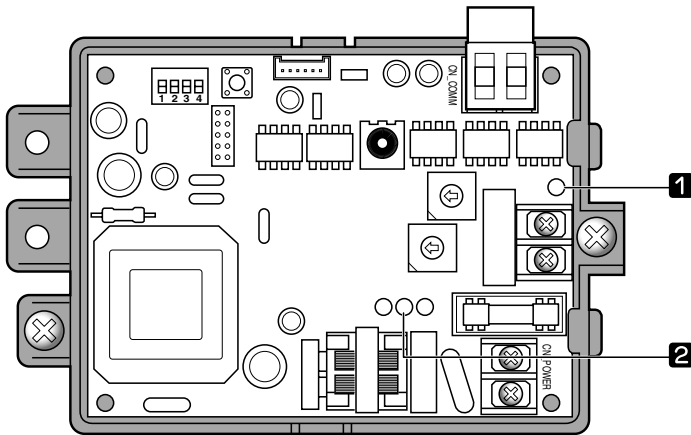

1 LD4 : 485 communication LED

2 LD2 : Relay status LED

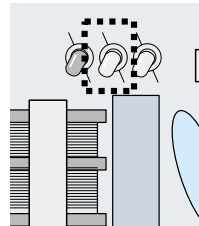
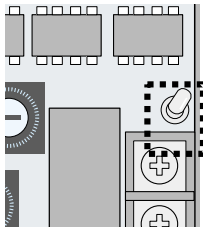

1. How to make sure that the central control is normally connected

- Make sure that the **1** LD4 periodically blinks.
- If the **1** LD4 does not periodically blink, make sure that the DIP switch and the rotary switch (address setting) are correct.
- Make sure that the BusA and the BusB line are correctly connected.

2. How to make sure that the relay is turned on/off

- If the relay is turned on, the **2** LD2 is turned on.
- If the relay is turned off, the **2** LD2 is turned off.

